



# Cushy Mount K



**17/1921 | 17/1872**

## Cushymount K

The Cushymount "K" Series Mountings have been developed primarily for the suspension of medium speed diesel units used for marine main propulsion and auxiliary power generation applications, but may also be considered for rail locomotive traction power units, gas turbines and compressors.

The load capacity range of the mountings extends from 20kN to 80kN with effective deflections of up to 10mm on the larger mounting. The dissimilar stiffness rates in the two horizontal modes enables optimisation of the suspension system to avoid resonances with major engine orders whilst providing a high degree of vibration isolation when operating with rotational speeds as low as 500 rpm.

The robust construction of the mount is designed to accommodate high shock forces, incorporating an integral buffer to limit vertical and horizontal displacement of the suspended equipment without the need for external limiting devices.

The mountings carry Lloyd's Register of Shipping type approval and for special requirements can be made available with a height adjustment feature.

## About Trelleborg Industrial AVS

Over 100 years of experience as Metalastik and Novibra, today Trelleborg Industrial AVS make improvements people can physically feel. From smoother travel to quieter, more efficient machines, we make life feel better. With quality, testing and compliance built in, we're in it for the long haul, ensuring your solution still works, over an extended and often arduous life-cycle.

With three state-of-the-art manufacturing plants across the globe, our experience in rubber to metal bonding enhances several industries, including off-highway vehicles, rail and mass transit, marine and energy and general industry.

We offer an end-to-end service, to take you from concept through design, manufacturing and testing to delivery. This reduces the complexity of supply, helping you cut costs, mitigate risk and receive on time, on budget delivery.

Trelleborg IAVS is part of Trelleborg Group, which employs 15,000 people in over 40 countries. Whatever your challenge, whatever your role and wherever you are, we are nearby to offer expert knowledge and quality solutions.



# Cushymount K 17/1921 | 17/1872

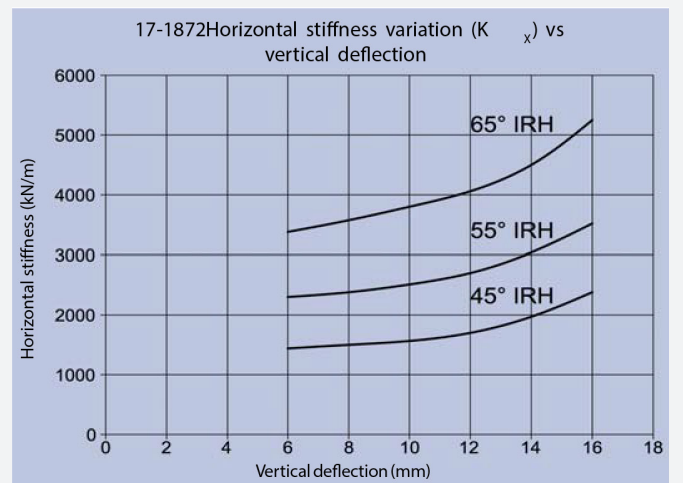
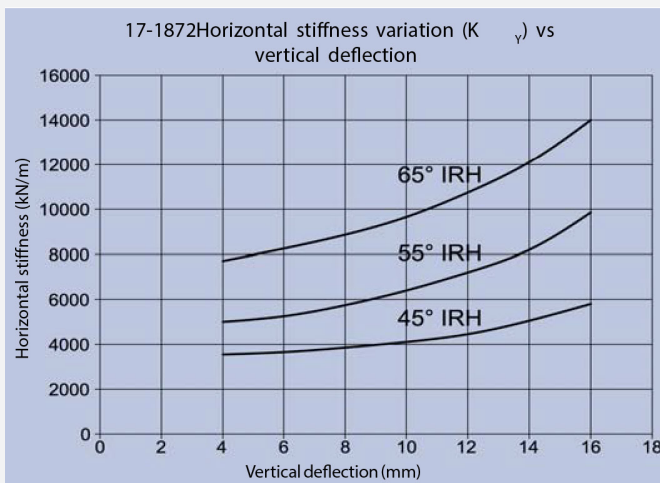
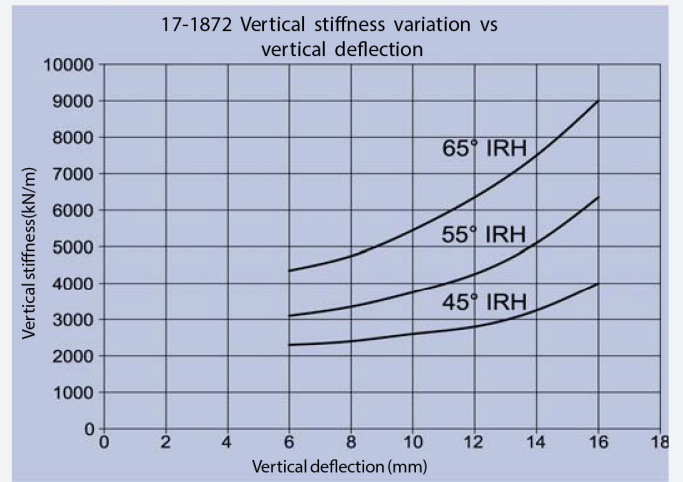
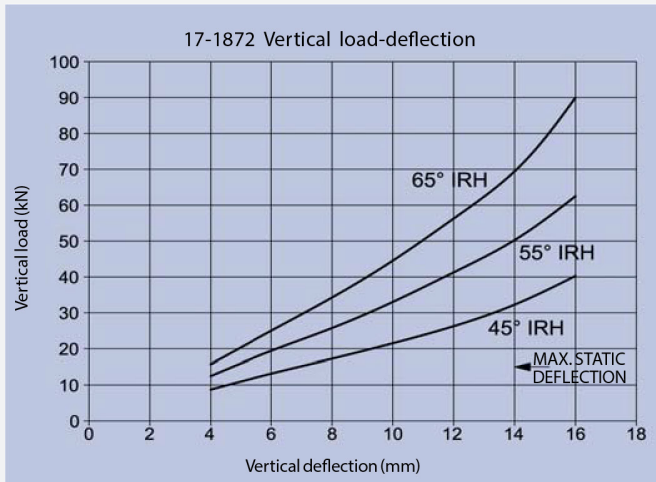



# Cushymount K 17/1921 | 17/1872

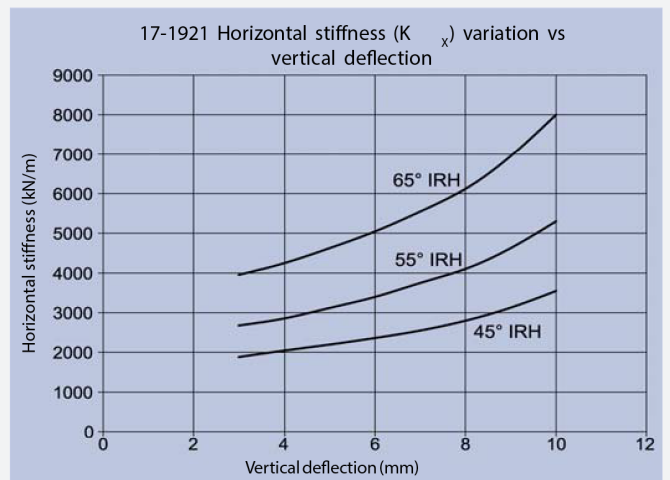
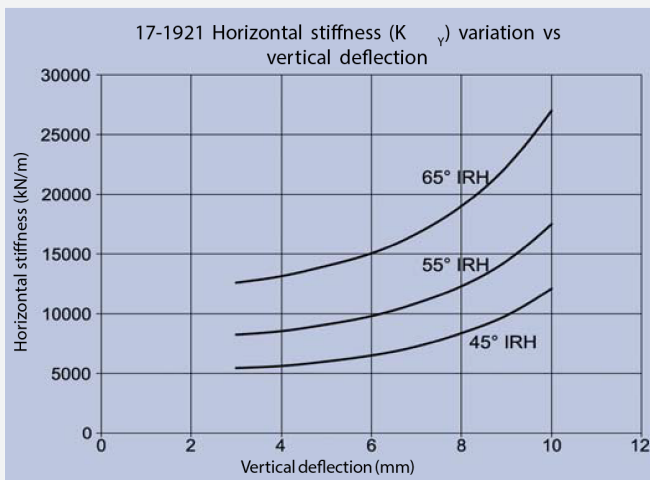
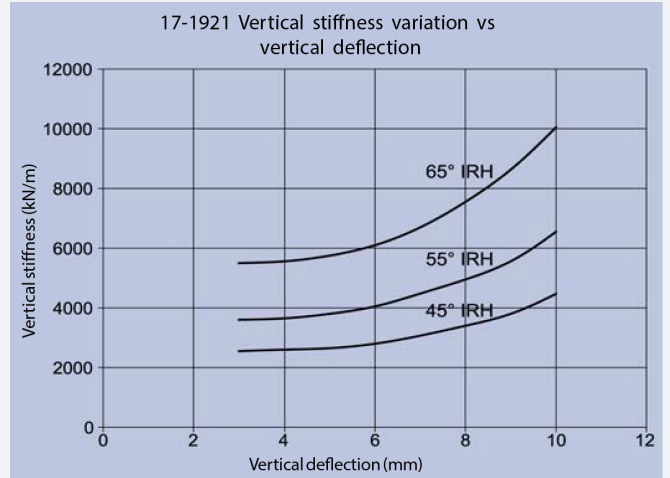
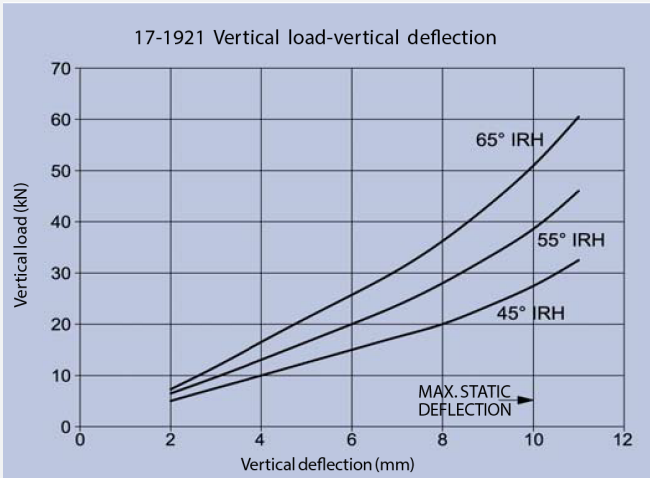

# Cushymount K 17/1921 | 17/1872

## Technical Drawing

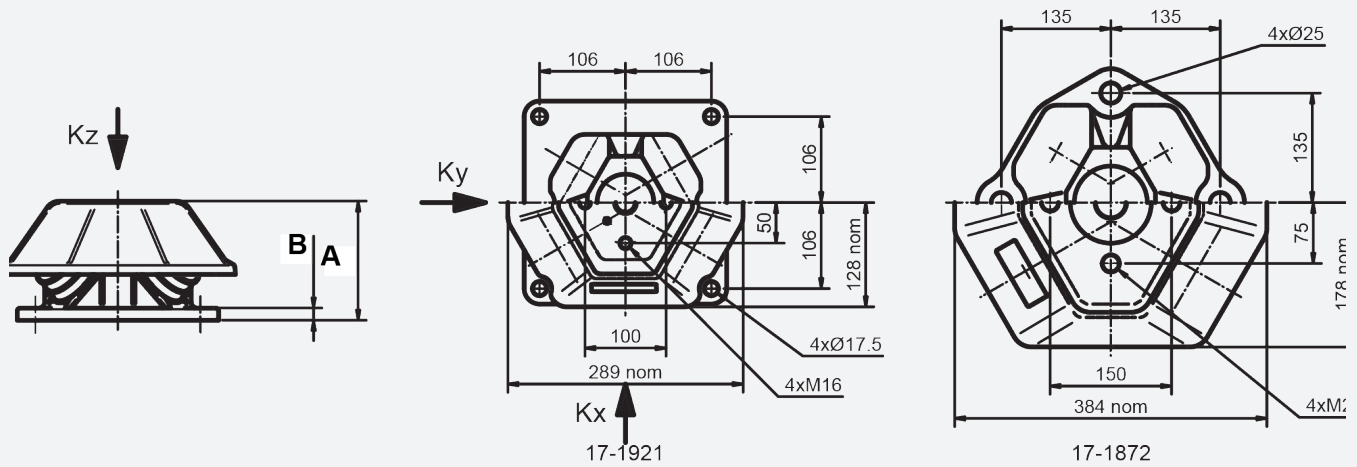

## Product Data

TYPE	A	B	NOMINAL RUBBER HARDNESS	MAXIMUM LOAD CAPACITY (kN)	NORMINAL DEFLECTION AT MAXIMUM LOAD	WEIGHT (KG)
17-1921	144	12	45	20	10	32
17-1921	144	12	55	38	10	32
17-1921	144	12	65	50	10	32
17-1872	195	20	45	35	14	50
17-1872	195	20	55	55	14	50
17-1872	195	20	65	80	14	50



[WWW.TRELLEBORG.COM/ANTI-VIBRATION-SOLUTIONS](http://WWW.TRELLEBORG.COM/ANTI-VIBRATION-SOLUTIONS)

For further information visit our website or e-mail [industrialavs@trelleborg.com](mailto:industrialavs@trelleborg.com)

The content in this datasheet was correct at the time of printing, but is subject to change without notice.