

The background of the entire page is a photograph of a wind farm at sunset. The sky is a mix of orange, yellow, and blue, with the sun low on the horizon. Several wind turbines are visible, their silhouettes and blades reflected in the calm water in the foreground. The overall mood is serene and industrial.

Cable Entry Solutions

PRODUCT PORTFOLIO



An aerial night view of a city skyline, likely Singapore, with numerous skyscrapers illuminated. Overlaid on the city are numerous vertical lines of various colors (blue, purple, pink, red) that extend from the ground up to the top of the frame, each ending in a small glowing dot. These lines represent data or connectivity. The sky is a deep blue with a hint of orange from the setting or rising sun.

Designed for your industry

A global leader in polymer engineering, Trelleborg Cable Entry Solutions specializes in the protection of cables to the world's most important equipment and infrastructure. Calling on over 100 years of experience, we deliver off-the-shelf products and bespoke solutions which add value to your operations. Found in everything from stationary and mobile installations through to machine tools and processing equipment, all our solutions are modeled, tested and certified to perform in the most demanding environments. Our reputation rests on our ability to deliver compliant and pioneering solutions which enhance equipment while reducing downtime, maintenance and long-term cost of ownership.

It's a difference you can see in your products and your brand reputation.



Table of Contents

Cable Entry Plates B10, B16, B24	6
Cable Entry Plates FL21	13
Cable Entry Plates FL13	20
Cable Entry Plates Special Cut-Out	24
Splitting Cable Entry Plates	26
TMS – Modular Cable Entry System	29
Cable Grommets	40

Advantages

- **Complete portfolio.** With our wide range of custom cable entry solutions matched by industry-leading expertise in this highly specialized niche, we're there to help you select the best system for your needs.
- **Connections.** We help you connect not just data and power, but your project chain and the people in it – making us a crucial link in joining everything up.
- **Protection.** With high-integrity polymer products that keep your cables, equipment, and operation working safely and efficiently.
- **Support.** Our global support network means we're accessible in all territories. Wherever you are, you'll have access to local engineering support and a robust and reliable supply chain.
- **Peace of mind.** Fully tested and compliant with all international standards, our market-leading solutions meet the high levels of safety and reassurance that the industrial industry demands.

Quality



Our high-quality products are the result of over 100 years' experience in the industrial sector. They're manufactured in world-class plants with superior materials and technology, and they're tested using sophisticated software and technology to ensure a lifetime of reliable performance. What's more, as part of a major international group, Trelleborg Cable Entry Solutions offers you the reassurance of financial strength, global support and ongoing investment in quality and testing.



Scan the QR codes with your smartphone to get detailed information about products.



Cable Entry Plates for B24 cut-out

MH24 F 23-1	Art.No.	Description	Packing
 Dimensions 154 x 96 x 19mm Weight 65g Installation Range (Ø) 4 x 1,5mm - 3mm 1 x 5,0mm - 10,0mm 4 x 3,2mm - 6,3mm 1 x 8mm - 12,5mm 10 x 4mm - 7,5mm 3 x 12mm - 16,2mm Total Of 23 cables	107566B	MH-24 F 23-1 LIGHT GREY UL94 V 0	Single
	107566	MH-24 F 23-1 LIGHT GREY UL94 V 0	Bulk
	107652B	MH-24 F 23-1 BLACK UL94 V 0	Single
	107652	MH-24 F 23-1 BLACK UL94 V 0	Bulk
MH24 F 23-2	Art.No.	Description	Packing
 Dimensions 154 x 96 x 19mm Weight 65g Installation Range (Ø) 4 x 1,5mm - 3mm 1 x 5,0mm - 10,0mm 6 x 3,2mm - 6,3mm 10 x 8mm - 12,5mm 2 x 4mm - 7,5mm Total Of 23 cables	107567B	MH-24 F 23-2 LIGHT GREY UL94 V 0	Single
	107567	MH-24 F 23-2 LIGHT GREY UL94 V 0	Bulk
	107657B	MH-24 F 23-2 BLACK UL94 V 0	Single
	107657	MH-24 F 23-2 BLACK UL94 V 0	Bulk



Cable Entry Plates B10, B16, B24



Advantages

- Fast and easy assembly
- High cable density
- Double sealing with high IP protection
- Hygienic design with a flat surface structure
- Suitable for both indoor and outdoor use

Technical Specifications

- Material: thermoplastic elastomer and fiberglass reinforced plastic
- Material properties: UL94 V-0 halogen-free
- Colour: light grey and black
- Material service temperature (unstressed): -40 °C...+90 °C



The cable entries in this “industrial connector series” match the cut-out dimensions of 10, 16 and 24-pin standards. They have been designed as an entry and fastening system for unassembled cables, tubes and hoses. These high cable density entries enable fast routing of cables into control cabinets, panels or machines.



Cable Entry Plates for B10 cut-out

MH10 F 12-1	Art.No.	Description	Box size	Packing
 <p>Dimensions 107 x 56 x 19mm</p> <p>Flammability rating UL94 V-0</p> <p>IP rating IP66</p> <p>Installation range (∅) 5 x 3mm - 7mm 2 x 7mm - 13mm 4 x 5mm - 10mm 1 x 9mm - 16mm</p> <p>Total of 12 cables</p>	107294	MH-10 F 12-1 LIGHT GREY UL94 V-0	100	Bulk
	107294B	MH-10 F 12-1 LIGHT GREY UL94 V-0	80	Single
	107293	MH-10 F 12-1 BLACK UL94 V-0	100	Bulk
	107293B	MH-10 F 12-1 BLACK UL94 V-0	80	Single



Cable Entry Plates for B16 cut-out

MH16 F 17-1	Art.No.	Description	Box size	Packing
 <p>Dimensions 127 x 56 x 19mm</p> <p>Flammability rating UL94 V-0</p> <p>IP rating IP66</p> <p>Installation range (∅) 12 x 3mm - 7mm 5 x 7mm - 13mm</p> <p>Total of 17 cables</p>	107295	MH-16 F 17-1 LIGHT GREY UL94 V-0	100	Bulk
	107295B	MH-16 F 17-1 LIGHT GREY UL94 V-0	80	Single
	107292	MH-16 F 17-1 BLACK UL94 V-0	100	Bulk
	107292B	MH-16 F 17-1 BLACK UL94 V-0	80	Single



Cable Entry Plates for B24 cut-out

MH24 F 17-2	Art.No.	Description	Box size	Packing
 <p>Dimensions 154 x 56 x 19mm</p> <p>Flammability rating UL94 V-0</p> <p>IP rating IP66</p> <p>Installation range (∅) 6 x 3mm - 7mm 5 x 9mm - 16mm 6 x 5mm - 10mm</p> <p>Total of 17 cables</p>	107296	MH-24 F 17-2 LIGHT GREY UL94 V-0	100	Bulk
	107296B	MH-24 F 17-2 LIGHT GREY UL94 V-0	80	Single
	107291	MH-24 F 17-2 BLACK UL94 V-0	100	Bulk
	107291B	MH-24 F 17-2 BLACK UL94 V-0	80	Single





Cable Entry Plates for B24 cut-out

MH24 F 17-3	Art.No.	Description	Box size	Packing
 <p>Dimensions 154 x 56 x 19mm</p> <p>Flammability rating UL94 V-0</p> <p>IP rating IP66</p> <p>Installation range (∅) 4 x 3mm - 7mm 1 x 10mm - 20mm 12 x 7mm - 20mm</p> <p>Total of 17 cables</p>	107466	MH-24 F 17-3 LIGHT GREY UL94 V-0	100	Bulk
	107466B	MH-24 F 17-3 LIGHT GREY UL94 V-0	80	Single
	107472	MH-24 F 17-3 BLACK UL94 V-0	100	Bulk
	107472B	MH-24 F 17-3 BLACK UL94 V-0	80	Single
MH24 F 19-1	Art.No.	Description	Box size	Packing
 <p>Dimensions 154 x 56 x 19mm</p> <p>Flammability rating UL94 V-0</p> <p>IP rating IP66</p> <p>Installation range (∅) 5 x 1,5mm - 3mm 4 x 16mm - 22mm 10 x 3,2mm - 6,5mm</p> <p>Total of 19 cables</p>	107558	MH-24 F 19-1 LIGHT GREY UL94 V-0	100	Bulk
	107558B	MH-24 F 19-1 LIGHT GREY UL94 V-0	80	Single
	107653	MH-24 F 19-1 BLACK UL94 V-0	100	Bulk
	107653B	MH-24 F 19-1 BLACK UL94 V-0	80	Single
MH24 F 20-1	Art.No.	Description	Box size	Packing
 <p>Dimensions 154 x 56 x 19mm</p> <p>Flammability rating UL94 V-0</p> <p>IP rating IP66</p> <p>Installation range (∅) 6 x 1,5mm - 3mm 14 x 7,2mm - 12mm</p> <p>Total of 20 cables</p>	107559	MH-24 F 20-1 LIGHT GREY UL94 V-0	100	Bulk
	107559B	MH-24 F 20-1 LIGHT GREY UL94 V-0	80	Single
	107654	MH-24 F 20-1 BLACK UL94 V-0	100	Bulk
	107654B	MH-24 F 20-1 BLACK UL94 V-0	80	Single
MH24 F 22-1	Art.No.	Description	Box size	Packing
 <p>Dimensions 154 x 56 x 19mm</p> <p>Flammability rating UL94 V-0</p> <p>IP rating IP66</p> <p>Installation range (∅) 15 x 3mm - 7mm 3 x 15mm - 20mm 4 x 4,5mm - 10mm</p> <p>Total of 22 cables</p>	107481	MH-24 F 22-1 LIGHT GREY UL94 V-0	100	Bulk
	107481B	MH-24 F 22-1 LIGHT GREY UL94 V-0	80	Single
	107513	MH-24 F 22-1 BLACK UL94 V-0	100	Bulk
	107513B	MH-24 F 22-1 BLACK UL94 V-0	80	Single

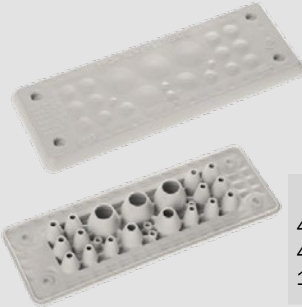

Cable Entry Plates for B24 cut-out

MH24 F 23-1		Art.No.	Description	Box size	Packing
 <p>Dimensions 154 x 56 x 19mm</p> <p>Flammability rating UL94 V-0</p> <p>IP rating IP66</p> <p>Installation range (Ø) 4 x 1,5mm - 3mm 1 x 5,5mm - 10,5mm 4 x 3,2mm - 6,3mm 1 x 8mm - 12,5mm 10 x 4mm - 7,5mm 3 x 12mm-16,2mm</p> <p>Total of 23 cables</p>	107555	MH-24 F 23-1 LIGHT GREY UL94 V-0	100	Bulk	
	107555B	MH-24 F 23-1 LIGHT GREY UL94 V-0	80	Single	
	107652	MH-24 F 23-1 BLACK UL94 V-0	100	Bulk	
	107652B	MH-24 F 23-1 BLACK UL94 V-0	80	Single	
MH24 F 23-2		Art.No.	Description	Box size	Packing
 <p>Dimensions 154 x 56 x 19mm</p> <p>Flammability rating UL94 V-0</p> <p>IP rating IP66</p> <p>Installation range (Ø) 4 x 1,5mm - 3mm 1 x 5,5mm - 10,5mm 6 x 3,2mm - 6,3mm 10 x 8mm - 12,5mm 2 x 4mm - 7,5mm</p> <p>Total of 23 cables</p>	107556	MH-24 F 23-2 LIGHT GREY UL94 V-0	100	Bulk	
	107556B	MH-24 F 23-2 LIGHT GREY UL94 V-0	80	Single	
	107657	MH-24 F 23-2 BLACK UL94 V-0	100	Bulk	
	107657B	MH-24 F 23-2 BLACK UL94 V-0	80	Single	
MH24 F 27-1		Art.No.	Description	Box size	Packing
 <p>Dimensions 154 x 56 x 19mm</p> <p>Flammability rating UL94 V-0</p> <p>IP rating IP66</p> <p>Installation range (Ø) 12 x 3mm - 7mm 5 x 7mm - 13mm 10 x 4,5mm - 10mm</p> <p>Total of 27 cables</p>	107480	MH-24 F 27-1 LIGHT GREY UL94 V-0	100	Bulk	
	107480B	MH-24 F 27-1 LIGHT GREY UL94 V-0	80	Single	
	107512	MH-24 F 27-1 BLACK UL94 V-0	100	Bulk	
	107512B	MH-24 F 27-1 BLACK UL94 V-0	80	Single	





Cable Entry Plates for B24 cut-out

MH24 F 30-1		Art.No.	Description	Box size	Packing
 <p>Dimensions 154 x 56 x 19mm</p> <p>Flammability rating UL94 V-0</p> <p>IP rating IP66</p> <p>Installation range (∅) 30 x 3mm - 8mm</p> <p>Total of 30 cables</p>	107465	MH-24 F 30-1 LIGHT GREY UL94 V-0	100	Bulk	
	107465B	MH-24 F 30-1 LIGHT GREY UL94 V-0	80	Single	
	107471	MH-24 F 30-1 BLACK UL94 V-0	100	Bulk	
	107471B	MH-24 F 30-1 BLACK UL94 V-0	80	Single	
MH24 F 30-2		Art.No.	Description	Box size	Packing
 <p>Dimensions 154 x 56 x 19mm</p> <p>Flammability rating UL94 V-0</p> <p>IP rating IP66</p> <p>Installation range (∅) 8 x 1,5mm - 3mm 6 x 5mm - 8,5mm 8 x 3,2mm - 5,5mm 2 x 9,5mm - 14,5mm 6 x 4mm - 7,5mm</p> <p>Total of 30 cables</p>	107554	MH-24 F 30-2 LIGHT GREY UL94 V-0	100	Bulk	
	107554B	MH-24 F 30-2 LIGHT GREY UL94 V-0	80	Single	
	107658	MH-24 F 30-2 BLACK UL94 V-0	100	Bulk	
	107658B	MH-24 F 30-2 BLACK UL94 V-0	80	Single	
MH24 F 30-3		Art.No.	Description	Box size	Packing
 <p>Dimensions 154 x 56 x 19mm</p> <p>Flammability rating UL94 V-0</p> <p>IP rating IP66</p> <p>Installation range (∅) 6 x 1,5mm - 3mm 14 x 4mm - 7,5mm 4 x 3,2mm - 6,3mm 2 x 8mm - 12,5mm</p> <p>Total of 30 cables</p>	107557	MH-24 F 30-3 LIGHT GREY UL94 V-0	100	Bulk	
	107557B	MH-24 F 30-3 LIGHT GREY UL94 V-0	80	Single	
	107659	MH-24 F 30-3 BLACK UL94 V-0	100	Bulk	
	107659B	MH-24 F 30-3 BLACK UL94 V-0	80	Single	



Cable Entry Plates for B24 cut-out

MH24 F 31-1		Art.No.	Description	Box size	Packing
 <p>Dimensions 154 x 56 x 19mm</p> <p>Flammability rating UL94 V-0</p> <p>IP rating IP66</p> <p>Installation range (∅) 20 x 3,2mm - 6,5mm 3 x 7,5mm - 12mm 8 x 5mm - 10,2mm</p> <p>Total of 31 cables</p>	107561	MH-24 F 31-1 LIGHT GREY UL94 V-0	100	Bulk	
	107561B	MH-24 F 31-1 LIGHT GREY UL94 V-0	80	Single	
	107655	MH-24 F 31-1 BLACK UL94 V-0	100	Bulk	
	107655B	MH-24 F 31-1 BLACK UL94 V-0	80	Single	
MH24 F 42-1		Art.No.	Description	Box size	Packing
 <p>Dimensions 154 x 56 x 19mm</p> <p>Flammability rating UL94 V-0</p> <p>IP rating IP66</p> <p>Installation range (∅) 42 x 3,2mm - 6,5mm</p> <p>Total of 42 cables</p>	107560	MH-24 F 42-1 LIGHT GREY UL94 V-0	100	Bulk	
	107560B	MH-24 F 42-1 LIGHT GREY UL94 V-0	80	Single	
	107656	MH-24 F 42-1 BLACK UL94 V-0	100	Bulk	
	107656B	MH-24 F 42-1 BLACK UL94 V-0	80	Single	
MH24 F 125-1		Art.No.	Description	Box size	Packing
 <p>Dimensions 154 x 56 x 11mm</p> <p>Flammability rating UL94 V-0</p> <p>IP rating IP66</p> <p>Installation range (∅) 123 x 1,5mm - 3mm 2 x 2,5mm - 5mm</p> <p>Total of 125 cables</p>	107562	MH-24 F 125-1 LIGHT GREY UL94 V-0	100	Bulk	
	107562B	MH-24 F 125-1 LIGHT GREY UL94 V-0	80	Single	
	107651	MH-24 F 125-1 BLACK UL94 V-0	100	Bulk	
	107651B	MH-24 F 125-1 BLACK UL94 V-0	80	Single	

A nighttime photograph of a city and mountains. The city lights are visible in the distance, and the mountains are silhouetted against the dark sky. In the foreground, a road curves through a dark landscape, with light trails from vehicles creating bright, curved streaks of light. The text "Cable Entry Plates FL 21" is overlaid in white, bold, sans-serif font.

Cable Entry Plates FL 21

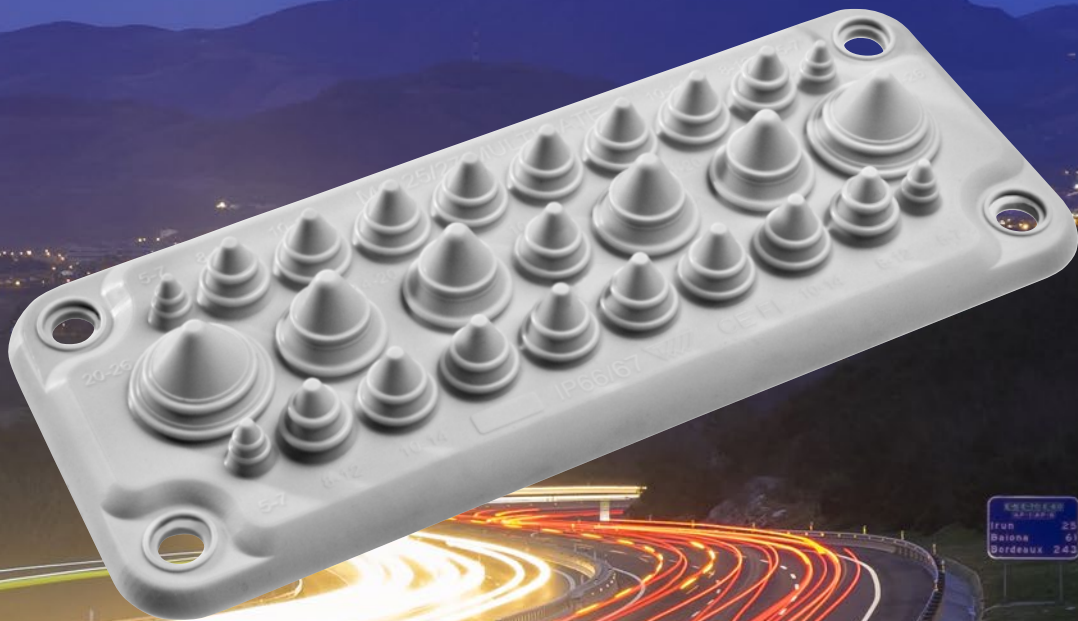

Advantages

- Fast and easy assembly
- High cable density
- Double sealing with excellent IP protection
- Suitable for both indoor and outdoor use

Technical Specifications



- Material: Thermoplastic elastomer
- Material properties: UL94 V-0
- Metal reinforcement: zinc coated steel
- Colour: Black or Light Grey
- Material service temperature (unstressed): -40 °C...+100 °C

This cut-out size is widely used especially in northern Europe. FL21 is commonly referred to as C size cut-out. Metal insert is used to reinforce the structure and it is made of zinc coated steel.

These membrane-based cable entry plates are designed to be used with cables without connectors, tubes and pneumatic or hydraulic hoses.



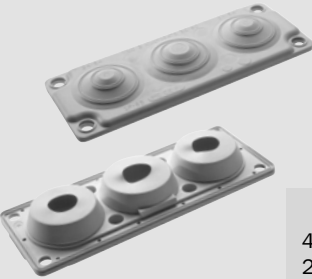

Cable Entry Plates for FL21 cut-out

MC 3	Art.No.	Description	Box size	Packing
 <p>Dimensions 214 x 84 x 37mm</p> <p>Flammability rating UL94 V-0</p> <p>IP rating IP65</p> <p>Installation range (Ø) 4 x 8mm - 12mm 1 x 30mm - 60mm 2 x 24mm - 54mm</p> <p>Total of 7 cables</p>	100235	MC 3 BLACK UL94 V-0	100	Bulk
	100235B	MC 3 BLACK UL94 V-0	80	Single
	107610	MC 3 LIGHT GREY UL94 V-0	100	Bulk
	107610B	MC 3 LIGHT GREY UL94 V-0	80	Single
MC 25	Art.No.	Description	Box size	Packing
 <p>Dimensions 216 x 84 x 24mm</p> <p>Flammability rating UL94 V-0</p> <p>IP rating IP65</p> <p>Installation range (Ø) 4 x 5mm - 7mm 4 x 14mm - 22mm 4 x 8mm - 12mm 1 x 20mm - 26mm 12 x 10mm - 14mm</p> <p>Total of 25 cables</p>	100239	MC 25 BLACK UL94 V-0	100	Bulk
	100239B	MC 25 BLACK UL94 V-0	80	Single
	107611	MC 25 LIGHT GREY UL94 V-0	100	Bulk
	107611B	MC 25 LIGHT GREY UL94 V-0	80	Single
MC 35	Art.No.	Description	Box size	Packing
 <p>Dimensions 216 x 84 x 31mm</p> <p>Flammability rating UL94 V-0</p> <p>IP rating IP65</p> <p>Installation range (Ø) 2 x 6mm - 10mm 2 x 12mm - 18mm 14 x 7mm - 12mm 1 x 17mm - 32mm 16 x 10mm - 14mm</p> <p>Total of 35 cables</p>	100245	MC 35 BLACK UL94 V-0	100	Bulk
	100245B	MC 35 BLACK UL94 V-0	80	Single
	107612	MC 35 LIGHT GREY UL94 V-0	100	Bulk
	107612B	MC 35 LIGHT GREY UL94 V-0	80	Single



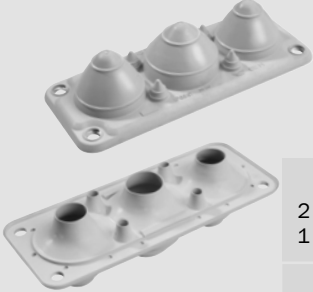

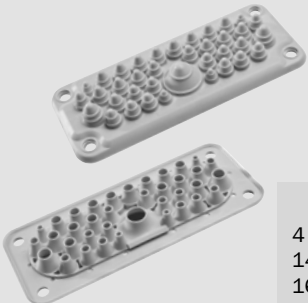
Cable Entry Plates for FL21 cut-out

MC 3/7		Art.No.	Description	Box size	Packing
 <p>Dimensions 222 x 92 x 76mm</p> <p>Flammability rating UL94 V-0</p> <p>IP rating IP67</p> <p>Installation range (Ø) 2 x 24mm - 54mm 4 x 10mm - 14mm 1 x 30mm - 60mm</p> <p>Total of 7 cables</p>	105041	MC 3/7 LIGHT GREY UL94 V-0	60	Bulk	
	105041B	MC 3/7 LIGHT GREY UL94 V-0	40	Single	
	103580	MC 3/7 BLACK UL94 V-0	60	Bulk	
	103580B	MC 3/7 BLACK UL94 V-0	40	Single	
MC 25/27		Art.No.	Description	Box size	Packing
 <p>Dimensions 222 x 92 x 43mm</p> <p>Flammability rating UL94 V-0</p> <p>IP rating IP67</p> <p>Installation range (Ø) 4 x 5mm - 7mm 4 x 14mm - 20mm 4 x 8mm - 12mm 2 x 20mm - 26mm 13 x 10mm - 14mm</p> <p>Total of 27 cables</p>	105042	MC 25/27 LIGHT GREY UL94 V-0	60	Bulk	
	105042B	MC 25/27 LIGHT GREY UL94 V-0	40	Single	
	103586	MC 25/27 BLACK UL94 V-0	60	Bulk	
	103586B	MC 25/27 BLACK UL94 V-0	40	Single	
MC 35/37		Art.No.	Description	Box size	Packing
 <p>Dimensions 222 x 92 x 43mm</p> <p>Flammability rating UL94 V-0</p> <p>IP rating IP67</p> <p>Installation range (Ø) 4 x 6mm - 10mm 2 x 12mm - 18mm 14 x 8mm - 12mm 1 x 17mm - 32mm 16 x 10mm - 14mm</p> <p>Total of 37 cables</p>	105043	MC 35/37 LIGHT GREY UL94 V-0	60	Bulk	
	105043B	MC 35/37 LIGHT GREY UL94 V-0	40	Single	
	103591	MC 35/37 BLACK UL94 V-0	60	Bulk	
	103591B	MC 35/37 BLACK V-0 UL94 V-0	40	Single	



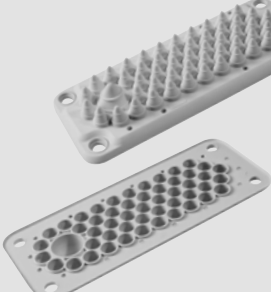

Cable Entry Plates for FL21 cut-out

LMC 14	Art.No.	Description	Box size	Packing
 <p>Dimensions 222 x 92 x 52mm</p> <p>Flammability rating UL94 V-0</p> <p>IP rating IP54</p> <p>Installation range (Ø) 5 x 10mm - 14mm 3 x 14mm - 22mm 4 x 14mm - 18mm 2 x 24mm - 54mm</p> <p>Total of 14 cables</p>	104338	LMC 14 LIGHT GREY UL94 V-0	100	Bulk
	104338B	LMC 14 LIGHT GREY UL94 V-0	40	Single
LMC 25	Art.No.	Description	Box size	Packing
 <p>Dimensions 222 x 92 x 30mm</p> <p>Flammability rating UL94 V-0</p> <p>IP rating IP54</p> <p>Installation range (Ø) 2 x 3mm - 11mm 5 x 14mm - 22mm 5 x 10mm - 14mm 1 x 14mm - 35mm 12 x 14mm - 18mm</p> <p>Total of 25 cables</p>	104335	LMC 25 LIGHT GREY UL94 V-0	100	Bulk
	104335B	LMC 25 LIGHT GREY UL94 V-0	40	Single
LMC 51	Art.No.	Description	Box size	Packing
 <p>Dimensions 222 x 92 x 30mm</p> <p>Flammability rating UL94 V-0</p> <p>IP rating IP54</p> <p>Installation range (Ø) 50 x 7mm - 13mm 1 x 15mm - 25mm</p> <p>Total of 51 cables</p>	104344	LMC 51 LIGHT GREY UL94 V-0	100	Bulk
	104344B	LMC 51 LIGHT GREY UL94 V-0	40	Single



Cable Entry Plates for FL21 cut-out

LMC 35	Art.No.	Description	Box size	Packing
 <p>Dimensions 214 x 84 x 9,5mm</p> <p>IP rating IP44</p> <p>Installation range (∅) 2 x 6mm - 11mm 2 x 12mm - 18mm 14 x 7mm - 12mm 1 x 15mm - 32mm 16 x 10mm - 14mm</p> <p>Total of 35 cables</p>	100241	LMC 35 LIGHT GREY	100	Bulk
	100241B	LMC 35 LIGHT GREY	80	Single
	Total of 35 cables			
MC 10	Art.No.	Description	Box size	Packing
 <p>Dimensions 216 x 84 x 48mm</p> <p>Flammability rating UL94 V-0</p> <p>IP rating IP55</p> <p>Installation range (∅) 2 x 7mm - 12mm 8 x 10mm - 30mm</p> <p>Total of 10 cables</p>	103552	MC 10 LIGHT GREY UL94 V-0	100	Bulk
	103552B	MC 10 LIGHT GREY UL94 V-0	50	Single
	Total of 10 cables			
MC 16	Art.No.	Description	Box size	Packing
 <p>Dimensions 216 x 84 x 31mm</p> <p>IP rating IP54</p> <p>Installation range (∅) 15 x 10mm - 20mm 1 x 10mm - 30mm</p> <p>Total of 16 cables</p>	100084	MC 16 LIGHT GREY	100	Bulk
	100084B	MC 16 LIGHT GREY	80	Single
	Total of 16 cables			

RMC Advantages

- Sealing rings can easily be pulled off without extra tools to make RMC perfectly fit various cable sizes making the installation very fast





RMC Technical Specifications

- Material: thermoplastic elastomer and fiber-glass reinforced plastic
- Material Properties: UL94 V-0
- Colour: black and light grey
- Standard M8 bolts used for mounting
- Material service temperature (unstressed): -40 °C...+90 °C



Cable Entry Plates for FL21 cut-out

RMC 3		Art.No.	Description	Box size	Packing
 <p>Dimensions 220 x 88 x 25,5mm</p> <p>Flammability rating UL94 V-0</p> <p>IP rating IP65</p> <p>Installation range (Ø) 4 x 7mm - 10mm 3 x 12mm - 57mm</p> <p>Total of 7 cables</p>	107360	RMC 3 LIGHT GREY UL94 V-0	100	Bulk	
	107360B	RMC 3 LIGHT GREY UL94 V-0	80	Single	
	107444	RMC 3 BLACK UL94 V-0	100	Bulk	
	107444B	RMC 3 BLACK UL94 V-0	80	Single	
RMC 17		Art.No.	Description	Box size	Packing
 <p>Dimensions 220 x 88 x 25,5mm</p> <p>Flammability rating UL94 V-0</p> <p>IP rating IP65</p> <p>Installation range (Ø) 4 x 5mm - 7mm 2 x 12mm - 15mm 2 x 10mm - 12mm 9 x 10mm - 30mm</p> <p>Total of 17 cables</p>	108424	RMC 17 LIGHT GREY UL94 V-0	100	Bulk	
	108424B	RMC 17 LIGHT GREY UL94 V-0	80	Single	
	106998	RMC 17 BLACK UL94 V-0	100	Bulk	
	106998B	RMC 17 BLACK UL94 V-0	80	Single	

Reinforced plastic insert is made robust, yet lightweight. These membrane-based cable entry plates are designed to be used with cables without connectors, tubes and pneumatic or hydraulic hoses.



Cable Entry Plates FL 13



Advantages

- Fast and easy assembly
- High cable density
- Screw mounting
- Suitable for both indoor and outdoor use

Technical Specifications

- Material: Thermoplastic elastomer (TPE)
- Colour: Light Grey
- Material Properties: UL94 V-0
- Metal reinforcement: zinc coated steel
- Material service temperature (unstressed): -40 °C...+100 °C

This cut-out size is used especially in northern Europe. FL13 is commonly referred to as B size cut-out. Metal insert is used to reinforce the structure and it is made of zinc coated steel.

These membrane-based cable entry plates are designed to be used with cables without connectors, tubes and pneumatic or hydraulic hoses.

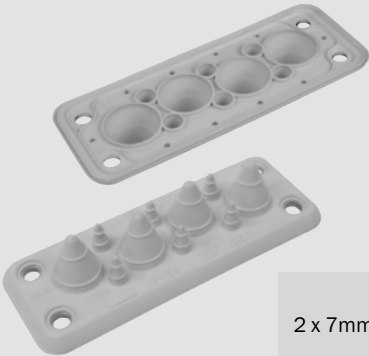
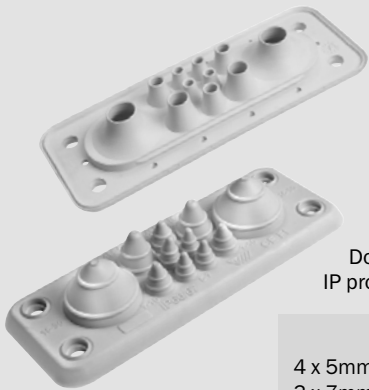

Cable Entry Plates for FL13 cut-out

MB 4/10	Art.No.	Description	Box size	Packing
 <p>Dimensions 147 x 57 x 31mm</p> <p>Flammability rating UL94 V-0</p> <p>IP rating IP54</p> <p>Installation range (∅) 2 x 7mm - 12mm 8 x 10mm - 30mm</p> <p>Total of 10 cables</p>	105954	MB 4/10 LIGHT GREY UL94 V-0	200	Bulk
	105954B	MB 4/10 LIGHT GREY UL94 V-0	100	Single
MB 5/11	Art.No.	Description	Box size	Packing
 <p>Dimensions 147 x 57 x 42mm</p> <p>Flammability rating UL94 V-0</p> <p>IP rating IP67</p> <p>Double sealing with excellent IP protection when cables are bent</p> <p>Installation range (∅) 4 x 5mm - 7mm 2 x 10mm - 14mm 3 x 7mm - 10mm 2 x 15mm - 30mm</p> <p>Total of 11 cables</p>	105044	MB 5/11 LIGHT GREY UL94 V-0	200	Bulk
	105044B	MB 5/11 LIGHT GREY UL94 V-0	100	Single

Cable Entry Plates Special Cut-Out





Cable Entry Plates for special cut-out

Advantages

- Fast and easy assembly
- High cable density
- Double sealing with high IP protection
- Suitable for both indoor and outdoor use

Technical Specifications

- Material: Thermoplastic elastomer
- Metal reinforcement: stainless steel
- Colour: Black
- Material properties: UL94 V-0
- Material service temperature (unstressed): -40 °C...+100 °C

MC 4	Art.No.	Description	Box size	Packing
 <p>Dimensions 300 x 88 x 36mm</p> <p>Flammability rating UL94 V-0</p> <p>IP rating IP65</p> <p>Installation range (Ø) 4 x 30mm - 63mm</p> <p>Total of 4 cables</p>	103888	MC 4x30-63 BLACK UL94 V-0	50	Bulk



Splitting Cable Entry Plates



Advantages

- Can be used with pre-terminated cables
- Robust design
- Good strain relief
- Suitable for both indoor and outdoor use

Technical Specifications

- Material: thermoplastic elastomer and fiberglass reinforced plastic
- Material properties: UL94 V-0
- Colour: black
- Material service temperature (unstressed): -40 °C...+100 °C

Often cables come with connectors that cannot be removed and re-attached. Trelleborg splitting multigates are a solution that allows the cables be installed with the connectors, and on top of that, the cables can be changed as often as wanted.



Splitting Cable Entry Plates

MC 1x8-64	Art.No.	Description	Box size	Packing
 <p>Dimensions 123 x 92 x 75mm</p> <p>Flammability rating UL94 V-0</p> <p>IP rating IP55</p> <p>Installation range (∅) 1 x 8mm - 64mm</p> <p>Total of 1 cable</p>	106582	MC 1x8-64 UL94 V-0	20	Bulk
MC 2x8-64	Art.No.	Description	Box size	Packing
 <p>Dimensions 222 x 92 x 75mm</p> <p>Flammability rating UL94 V-0</p> <p>IP rating IP55</p> <p>Installation range (∅) 2 x 8mm - 64mm</p> <p>Total of 2 cables</p>	100074	MC 2x8-64 UL94 V-0	10	Bulk
SCG 1x3-35	Art.No.	Description	Box size	Packing
 <p>Dimensions 77 x 60 x 40mm</p> <p>Flammability rating UL94 V-0</p> <p>IP rating IP55</p> <p>Installation range (∅) 2 x 3mm - 35mm</p> <p>Total of 1 cable</p>	105928	SCG 1x3-35 UL94 V-0	100	Bulk
SCG 2x3-35	Art.No.	Description	Box size	Packing
 <p>Dimensions 136 x 60 x 40mm</p> <p>Flammability rating UL94 V-0</p> <p>IP rating IP55</p> <p>Installation range (∅) 2 x 3mm - 35mm</p> <p>Total of 2 cables</p>	105929	SCG 2x3-35 UL94 V-0	51	Bulk



TMS – Modular Cable Entry System

Multiple benefits One system

Be inspired by new possibilities. Introducing the Trelleborg Modular System (TMS): our new cable entry system featuring over 1,000 potential configurations – so, whatever your application, you can be sure it never felt better. Flexibility and durability. Speed and customizability. All in one system. The TMS enables you to mount assembled and unassembled cables and pneumatic hoses quickly and easily, with a range of dimensions to cater for even the trickiest diameters. And, with seals offering up to protection class IP65, reliability is guaranteed.

- **Space-saving:** Internal plug connections for a smarter finish
- **Easy-fit:** No special tools or skills required to install
- **Safe:** Robust, oil-resistant design maximizes safety
- **Reliable:** Features strain relief in accordance with DIN EN 62444
- **Flexible:** Extensive variability for retrofits, with the highest cable density
- **All-encompassing:** An extensive range means there's always a solution
- **Stable:** Metal inserts and plastic frames give high vibration-proof stability
- **Guaranteed:** Be reassured with retained guarantees for pre-assembled cables
- **Standard-setting:** Cutouts correspond to all industry-standard connectors

Features and benefits

Reduces space and saves costs

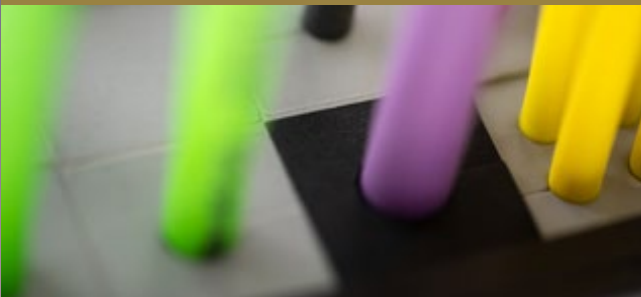

Variable mounting options



Fast installation with reliable seal



High stability, vibration proof



Cable grommets for your needs



For pre-assembled cables



Optional locking latch



To view these features and benefits in more detail, visit:
www.cable-entry-solutions.com

Explore for solutions



**Snap-in
mounting
frame**

**High
dimensional
stability of
the cable
entry frames
due to metal
reinforcement**

**Extensive
product range
- designs for
over 1000
different
configurations**

**Reliable
sealing up to
a protection
class of IP65**





Optional locking system for an easy installation

Easy handling: no special tools required

High level of safety thanks to robust and oil-resistant designs



Modular Cable Entry Frames

WITH LOCKING LATCH	Cutout	Specification	Art.No.
 <p>Material Polyamide, halogen-free, silicone-free</p> <p>Color Black</p> <p>Temperature range -40...+120°C</p> <p>IP Rating IP54</p> <p>Flammability classification UL94 V0</p>	B10 35 x 65mm	for accommodating up to 6 (small) cable grommets	107703
	B16 35 x 86mm	for accommodating up to 8 (small) cable grommets	107702
	B24 35 x 113mm	for accommodating up to 10 (small) cable grommets	107701
WITH SCREW LOCKING	Cutout	Specification	Art.No.
 <p>Material Polyamide, halogen-free, silicone-free</p> <p>Color Black</p> <p>Temperature range -40...+120°C</p> <p>IP Rating IP54/IP65</p> <p>Flammability classification UL94 V0</p>	B10 35 x 65mm	for accommodating up to 6 (small) cable grommets	107706
	B16 35 x 86mm	for accommodating up to 8 (small) cable grommets	107705
	B24 35 x 113mm	for accommodating up to 10 (small) cable grommets	107704
SNAP-IN MOUNTING FRAME	Cutout	Specification	Art.No.
 <p>Material Polyamide, halogen-free, silicone-free</p> <p>Color Black</p> <p>Temperature range -40...+120°C</p> <p>IP Rating IP54/IP65</p> <p>Flammability classification UL94 V0</p>	B10 35 x 65mm	for accommodating up to 6 (small) cable grommets	107703
	B16 35 x 86mm	for accommodating up to 8 (small) cable grommets	107702
	B24 35 x 113mm	for accommodating up to 10 (small) cable grommets	107701





Accessories for Modular Cable Entry Systems

FLAT GASKET		Cutout	Specification	Art.No.	
		B10 35 x 65mm	Spare gasket for sealing frame with standard cutout B10	107934	
		B16 35 x 86mm	Spare gasket for sealing frame with standard cutout B16	107935	
		B24 35 x 113mm	Spare gasket for sealing frame with standard cutout B24	107936	
REPLACEMENT SCREW		Specification		Art.No.	
		M4 replacement locking screw, Allen screw head, for sealing frames with screw locking		107937	
EMC CABLE SHIELDED RAILS		Specification		Art.No.	
		for mounting on the long side of the sealing frame TMS-B10		107940	
		for mounting on the long side of the sealing frame TMS-B16		107938	
		for mounting on the long side of the sealing frame TMS-B24		107939	
FILLER PLUGS		Ø Hole	Art.No.	Ø Hole	Art.No.
<p>Material Polyamide, halogen-free, silicone-free</p> <p>Temperature range -20...+80°C</p> <p>IP Rating IP54</p> <p>Flammability classification UL94 V0</p>		2mm	107901	10mm	107915
		3mm	107908	11mm	107916
		4mm	107909	12mm	107902
		5mm	107910	13mm	107903
		6mm	107911	14mm	107904
		7mm	107912	15mm	107905
		8mm	107913	16mm	107906
		9mm	107914	17mm	107907

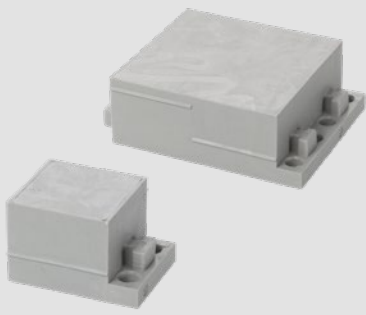

Material: SEBS / Cable Grommets IP65/IP54

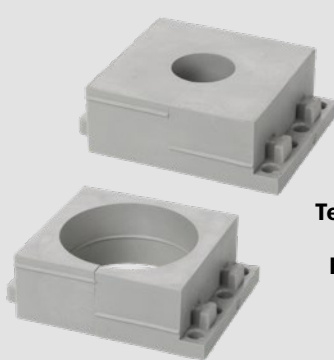
WITHOUT BORE HOLE, IP65		Dimensions		Art.No.
 <p>Material SEBS</p> <p>Color Grey</p> <p>Temperature range -40...+80°C</p> <p>Flammability classification UL94 V0</p> <p>Certified according to UL 508</p> <p>IP Rating IP 65</p>	Small (29.5 x 19.5 x 17mm)		107840	
	Large (53 x 39 x 17mm)		107841	
SMALL, SPLIT, IP54	Ø Cable	Art.No.	Ø Cable	Art.No.
 <p>Material SEBS</p> <p>Color Grey</p> <p>Dimensions 29,5 x 19,5 x 17mm</p> <p>Temperature range -40...+80°C</p> <p>Flammability classification UL94 V0</p> <p>IP Rating IP 54</p>	1-2mm	107801	9-10mm	107809
	2-3mm	107802	10-11mm	107810
	3-4mm	107803	11-12mm	107811
	4-5mm	107804	12-13mm	107812
	5-6mm	107805	13-14mm	107813
	6-7mm	107806	14-15mm	107850
	7-8mm	107807	15-16mm	107851
	8-9mm	107808	16-17mm	107852
LARGE, SPLIT, IP54	Ø Cable	Art.No.	Ø Cable	Art.No.
 <p>Material SEBS</p> <p>Color Grey</p> <p>Dimensions 53 x 39 x 17mm</p> <p>Temperature range -40...+80°C</p> <p>Flammability classification UL94 V0</p> <p>IP Rating IP 54</p>	14-15mm	107814	24-25mm	107824
	15-16mm	107815	25-26mm	107825
	16-17mm	107816	26-27mm	107826
	17-18mm	107817	27-28mm	107827
	18-19mm	107818	28-29mm	107828
	19-20mm	107819	29-30mm	107829
	20-21mm	107820	30-31mm	107830
	21-22mm	107821	31-32mm	107831
	22-23mm	107822	32-33mm	107832
	23-24mm	107823		



Material: SEBS / Cable Grommets IP54

SMALL, SPLIT, WITH 2 OR 4 BORE HOLES



Material
SEBS

Color
Grey

Dimensions
29,5 x 19,5 x 17mm

Temperature range
-40...+80°C

Flammability classification
UL94 V0

IP Rating
IP 54



Ø Cable	Specification	Art.No.
2x2-3mm	for cable outer diameter 2 x 2-3 mm	107847
2x3-4mm	for cable outer diameter 2 x 3-4 mm	107848
2x4-5mm	for cable outer diameter 2 x 4-5 mm	107833
2x5-6mm	for cable outer diameter 2 x 5-6 mm	107834
2x6-7mm	for cable outer diameter 2 x 6-7 mm	107853
2x7-8mm	for cable outer diameter 2 x 7-8 mm	107844
2x8-9mm	for cable outer diameter 2 x 8-9 mm	107849
4x2-3mm	for cable outer diameter 4 x 2-3 mm	107835
4x3-4mm	for cable outer diameter 4 x 3-4 mm	107836
4x4-5mm	for cable outer diameter 4 x 4-5 mm	107845
4x5-6mm	for cable outer diameter 4 x 5-6 mm	107846

SMALL, SPLIT, FOR AS-INTERFACE CABLES

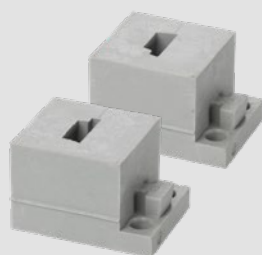

Material
SEBS

Color
Grey

Dimensions
29,5 x 19,5 x 17mm

Temperature range
-40...+80°C

Flammability classification
UL94 V0

IP Rating
IP 54



Specification	Art.No.
for one AS-Interface cable: R	107837
for two AS-Interface cables: LR	107839
for two AS-Interface cables: RR	107838
for one AS-Interface cable: L	107842
for two AS-Interface cables: LL	107843



Material: NBR / Cable Grommets IP65/IP54

CONED GROMMETS, IP65		Dimensions		Art.No.	
	Material NBR Color Black Temperature range -40...+125°C IP Rating IP 65	Small (29.5 x 19.5 x 17mm) cable 2-11 mm	107764		
		Large (53 x 39 x 17mm) cable 7-24 mm	107763		
WITHOUT BORE HOLE, IP65		Dimensions		Art.No.	
	Material NBR Color Black Temperature range -40...+125°C IP Rating IP 65	Small (29.5 x 19.5 x 17mm)	107730		
		Large (53 x 39 x 17mm)	107762		
SMALL, SPLIT, IP54		Ø Cable	Art.No.	Ø Cable	Art.No.
	Material NBR Color Black Dimensions 29,5 x 19,5 x 17mm Temperature range -40...+125°C IP Rating IP 54	1-2mm	107722	9-10mm	107714
		2-3mm	107721	10-11mm	107713
		3-4mm	107720	11-12mm	107712
		4-5mm	107719	12-13mm	107711
		5-6mm	107718	13-14mm	107710
		6-7mm	107717	14-15mm	107740
		7-8mm	107716	15-16mm	107741
		8-9mm	107715	16-17mm	107742
LARGE, SPLIT, IP54		Ø Cable	Art.No.	Ø Cable	Art.No.
	Material NBR Color Black Dimensions 53 x 39 x 17mm Temperature range -40...+125°C IP Rating IP 54	14-15mm	107743	24-25mm	107753
		15-16mm	107744	25-26mm	107754
		16-17mm	107745	26-27mm	107755
		17-18mm	107746	27-28mm	107756
		18-19mm	107747	28-29mm	107757
		19-20mm	107748	29-30mm	107758
		20-21mm	107749	30-31mm	107759
		21-22mm	107750	31-32mm	107760
		22-23mm	107751	32-33mm	107761
		23-24mm	107752		



Material: NBR / Cable Grommets IP54

SMALL, SPLIT, WITH 2 OR 4 BORE HOLES



Material
NBR

Color
Black

Dimensions
29,5 x 19,5 x 17mm

Temperature range
-40...+125°C

IP Rating
IP 54



Ø Cable	Specification	Art.No.
2x2-3mm	for cable outer diameter 2 x 2-3 mm	107737
2x3-4mm	for cable outer diameter 2 x 3-4 mm	107738
2x4-5mm	for cable outer diameter 2 x 4-5 mm	107723
2x5-6mm	for cable outer diameter 2 x 5-6 mm	107724
2x6-7mm	for cable outer diameter 2 x 6-7 mm	107733
2x7-8mm	for cable outer diameter 2 x 7-8 mm	107734
2x8-9mm	for cable outer diameter 2 x 8-9 mm	107739
4x2-3mm	for cable outer diameter 4 x 2-3 mm	107725
4x3-4mm	for cable outer diameter 4 x 3-4 mm	107726
4x4-5mm	for cable outer diameter 4 x 4-5 mm	107735
4x5-6mm	for cable outer diameter 4 x 5-6 mm	107736

SMALL, SPLIT, FOR AS-INTERFACE CABLES



Material
NBR

Color
Black

Dimensions
29,5 x 19,5 x 17mm

Temperature range
-40...+125°C

IP Rating
IP 54



Specification	Art.No.
for one AS-Interface cable: R	107727
for two AS-Interface cables: LR	107729
for two AS-Interface cables: RR	107728
for one AS-Interface cable: L	107731
for two AS-Interface cables: LL	107732



Cable Grommets



Trelleborg Cable Grommets are grommets with various designs based on IP rating and application. These grommets can be used to lead through both low and medium voltage power cables, tubes and hoses. There are options that match the cut-outs that are based on PG dimensions, as well as on mm dimensions.

Cable Grommets are made of various types of polymers that are RoHS compliant and have excellent weather resistance. Also fire retardant and oil resistant models are available.



Cable Grommets

T-VET

Advantages

- Fast and easy assembly
- Double sealing with high IP protection
- Suitable for both indoor and outdoor use
- Fit PG cut-out dimensions

Technical Specifications

- IP rating: IP67
- Material: thermoplastic elastomer
- Material properties: UL94 V-0
- Colour: light grey and black
- Material service temperature (unstressed): -40 °C...+100 °C

Dimensions

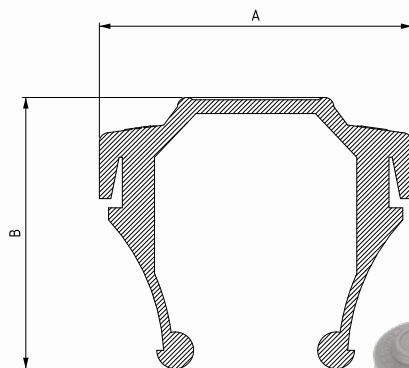

All dimensions to be used only as reference and not for quality control purposes



Art.No.	Description	Cable diameter	Cut-out	A	B	Plate thickness	Box size	Packing
100746	T-VET 3-5 LIGHT GREY UL94 V-0	3mm - 5mm	PG7	20	20	1mm - 4mm	1 800	Bulk
100747	T-VET 3-5 BLACK UL94 V-0	3mm - 5mm	PG7	20	20	1mm - 4mm	1 800	Bulk
100749	T-VET 5-7 LIGHT GREY UL94 V-0	5mm - 7mm	PG9	20	22	1mm - 4mm	1 500	Bulk
100187	T-VET 5-7 BLACK UL94 V-0	5mm - 7mm	PG9	20	22	1mm - 4mm	1 500	Bulk
100751	T-VET 7-10 LIGHT GREY UL94 V-0	7mm - 10mm	PG11	24	24	1mm - 4mm	1 200	Bulk
100188	T-VET 7-10 BLACK UL94 V-0	7mm - 10mm	PG11	24	24	1mm - 4mm	1 200	Bulk
100190	T-VET 10-14 LIGHT GREY UL94 V-0	10mm - 14mm	PG16	30	27	1mm - 4mm	700	Bulk
100191	T-VET 10-14 BLACK UL94 V-0	10mm - 14mm	PG16	30	27	1mm - 4mm	700	Bulk
100192	T-VET 14-20 LIGHT GREY UL94 V-0	14mm - 20mm	PG21	34	29	1mm - 4mm	400	Bulk
100193	T-VET 14-20 BLACK UL94 V-0	14mm - 20mm	PG21	34	29	1mm - 4mm	400	Bulk
100755	T-VET 20-26 LIGHT GREY UL94 V-0	20mm - 26mm	PG29	46	34	1mm - 4mm	250	Bulk
100195	T-VET 20-26 BLACK UL94 V-0	20mm - 26mm	PG29	46	34	1mm - 4mm	250	Bulk
100197	T-VET 26-35 LIGHT GREY UL94 V-0	26mm - 35mm	PG37	58	40	1mm - 4mm	120	Bulk
100198	T-VET 26-35 BLACK UL94 V-0	26mm - 35mm	PG38	58	40	1mm - 4mm	120	Bulk



Cable Grommets

T-GET

Advantages

- Fast and easy assembly
- Double sealing with high IP protection
- Suitable for both indoor and outdoor use
- Fit cut-out dimensions in mm

Technical Specifications

- IP rating: IP67
- Material: thermoplastic elastomer
- Material properties: UL94 V-0
- Colour: light grey and black
- Material service temperature (unstressed): -40 °C...+100 °C

Dimensions

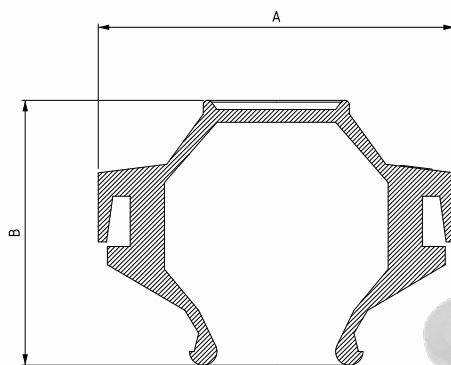

All dimensions to be used only as reference and not for quality control purposes

Art.No.	Description	Cable diameter	Cut-out	A	B	Plate thickness	Box size	Packing
100723	T-GET 3-5 LIGHT GREY UL 94 V-0	3mm - 5mm	M12	19	21	1mm - 5mm	1 500	Bulk
100724	T-GET 3-5 BLACK UL94 V-0	3mm - 5mm	M12	19	21	1mm - 5mm	1 500	Bulk
100726	T-GET 5-7 LIGHT GREY UL94 V-0	5mm - 7mm	M16	23	22	1mm - 5mm	1 500	Bulk
100727	T-GET 5-7 BLACK UL94 V-0	5mm - 7mm	M16	23	22	1mm - 5mm	1 500	Bulk
100729	T-GET 7-10 LIGHT GREY UL94 V-0	7mm - 10mm	M20	27	25	1mm - 5mm	1 000	Bulk
100730	T-GET 7-10 BLACK UL94 V-0	7mm - 10mm	M20	27	25	1mm - 5mm	1 000	Bulk
100732	T-GET 10-14 LIGHT GREY UL94 V-0	10mm - 14mm	M25	32	25	1mm - 5mm	600	Bulk
100733	T-GET 10-14 BLACK UL94 V-0	10mm - 14mm	M25	32	25	1mm - 5mm	600	Bulk
100735	T-GET 14-20 LIGHT GREY UL94 V-0	14mm - 20mm	M32	39	29	1mm - 5mm	400	Bulk
100736	T-GET 14-20 BLACK UL94 V-0	14mm - 20mm	M32	39	29	1mm - 5mm	400	Bulk
100183	T-GET 20-26 LIGHT GREY UL94 V-0	20mm - 26mm	M40	46	33	1mm - 5mm	250	Bulk
100184	T-GET 20-26 BLACK UL94 V-0	20mm - 26mm	M40	46	33	1mm - 5mm	250	Bulk
100739	T-GET 26-35 LIGHT GREY UL94 V-0	26mm - 35mm	M50	57	40	1mm - 5mm	140	Bulk
100740	T-GET 26-35 BLACK UL94 V-0	26mm - 35mm	M50	57	40	1mm - 5mm	140	Bulk
100741	T-GET 30-45 LIGHT GREY UL94 V-0	30mm - 45mm	M63	69	61	1mm - 5mm	175	Bulk
100185	T-GET 30-45 BLACK UL94 V-0	30mm - 45mm	M63	69	61	1mm - 5mm	175	Bulk
100743	T-GET 40-60 BLACK UL94 V-0	40mm - 60mm	M75	89	79	1.2mm - 5.2mm	80	Bulk



Cable Grommets

VET

Advantages

- Fast and easy assembly
- Double sealing with high IP protection
- Suitable for both indoor and outdoor use
- Fit PG cut-out dimensions

Technical Specifications

- IP rating: IP67
- Material: EPDM rubber
- Material properties: halogen-free
- Colour: grey and black
- Material service temperature (unstressed): -40 °C...+120 °C

Dimensions

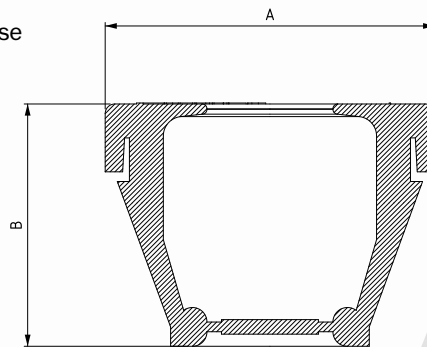

All dimensions to be used only as reference and not for quality control purposes



Art.No.	Description	Cable diameter	Cut-out	A	B	Plate thickness	Box size	Packing
100715B	VET 3-5 BLACK EPDM	3mm - 5mm	PG7	20	13	1mm - 4mm	1 000	Single
100716B	VET 3-5 GREY EPDM	3mm - 5mm	PG7	20	13	1mm - 4mm	1 000	Single
100306B	VET 5-7 BLACK EPDM	5mm - 7mm	PG9	20	20	1mm - 4mm	1 000	Single
100307B	VET 5-7 GREY EPDM	5mm - 7mm	PG9	20	20	1mm - 4mm	1 000	Single
100291B	VET 8-14 BLACK EPDM	8mm - 14mm	PG16	28	24	1mm - 4mm	1 000	Single
100292B	VET 8-14 GREY EPDM	8mm - 14mm	PG16	28	24	1mm - 4mm	1 000	Single
100295B	VET 7-10 BLACK EPDM	7mm - 10mm	PG11	24	21	1mm - 4mm	1 000	Single
100296B	VET 7-10 GREY EPDM	7mm - 10mm	PG11	24	21	1mm - 4mm	1 000	Single
100297B	VET 14-20 BLACK EPDM	14mm - 20mm	PG21	34	26	1mm - 4mm	500	Single
100298B	VET 14-20 GREY EPDM	14mm - 20mm	PG21	34	26	1mm - 4mm	500	Single
100300B	VET 20-26 BLACK EPDM	20mm - 26mm	PG29	46	30	1mm - 4mm	500	Single
100301B	VET 20-26 GREY EPDM	20mm - 26mm	PG29	46	30	1mm - 4mm	500	Single
100304B	VET 26-35 BLACK EPDM	26mm - 35mm	PG36	48	30	1mm - 4mm	200	Single
100305B	VET 26-35 GREY EPDM	26mm - 35mm	PG36	48	30	1mm - 4mm	200	Single



Cable Grommets

GET

Advantages

- Fast and easy assembly
- Double sealing with high IP protection
- Suitable for both indoor and outdoor use
- Fit cut-out dimensions in mm

Technical Specifications

- IP rating: IP67
- Material: EPDM rubber
- Material properties: halogen free
- Colour: grey and black
- Material service temperature (unstressed): -40 °C...+120 °C

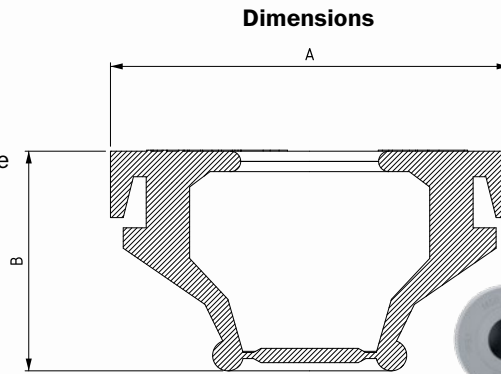

All dimensions to be used only as reference and not for quality control purposes



Art.No.	Description	Cable diameter	Cut-out	A	B	Plate thickness	Box size	Packing
100589B	GET 3-5 BLACK EPDM	3mm - 5mm	M12	19	19	1,3 - 5mm	1 000	Single
100590B	GET 3-5 GREY EPDM	3mm - 5mm	M12	19	19	1,3 - 5mm	1 000	Single
100587B	GET 5-7 BLACK EPDM	5mm - 7mm	M16	23	19	1,3 - 5mm	1 000	Single
100231B	GET 5-7 GREY EPDM	5mm - 7mm	M16	23	19	1,3 - 5mm	1 000	Single
100578B	GET 7-10 BLACK EPDM	7mm - 10mm	M20	27	20	1,3 - 5mm	1 000	Single
100226B	GET 7-10 GREY EPDM	7mm - 10mm	M20	27	20	1,3 - 5mm	1 000	Single
100574B	GET 10-14 BLACK EPDM	10mm - 14mm	M25	32	20	1,3 - 5mm	1 000	Single
100167B	GET 10-14 GREY EPDM	10mm - 14mm	M25	32	20	1,3 - 5mm	1 000	Single
100227B	GET 14-20 BLACK EPDM	14mm - 20mm	M32	39	22	1,3 - 5mm	500	Single
100228B	GET 14-20 GREY EPDM	14mm - 20mm	M32	39	22	1,3 - 5mm	500	Single
100583B	GET 20-26 BLACK EPDM	20mm - 26mm	M40	47	24	1,3 - 5mm	500	Single
100584B	GET 20-26 GREY EPDM	20mm - 26mm	M40	47	24	1,3 - 5mm	500	Single
100229B	GET 26-35 BLACK EPDM	26mm - 35mm	M50	58	30	1,3 - 5mm	200	Single
100230B	GET 26-35 GREY	26mm - 35mm	M50	58	30	1,3 - 5mm	200	Single
100223B	GET 30-45 BLACK EPDM	30mm - 45mm	M63	69	45	1,3 - 5mm	100	Single
100224B	GET 30-45 GREY EPDM	30mm - 45mm	M63	69	45	1,3 - 5mm	100	Single
100573B	GET40-60 BLACK EPDM	40mm - 60mm	M75	90	60	1,3 - 5mm	50	Single
100225B	GET 40-60 GREY EPDM	40mm - 60mm	M75	90	60	1,3 - 5mm	50	Single



Cable Grommets

T-GD

Advantages

- Fast and easy assembly
- Suitable for both indoor and outdoor use
- Fit PG cut-out dimensions
- Can be used as a plug

Technical Specifications

- IP rating: IP54 (IP65 if used as a plug)
- Material: thermoplastic elastomer
- Material properties: UL94 V-0
- Colour: black
- Material service temperature (unstressed): -40 °C...+100 °C

Dimensions

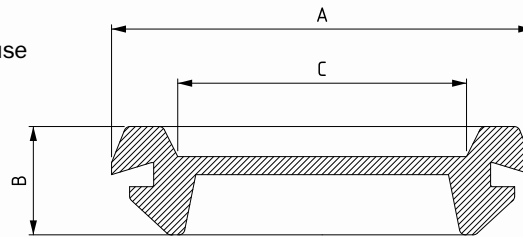

All dimensions to be used only as reference and not for quality control purposes



Art.No.	Description	Cut-out	A	B	C	Plate thickness	Box size	Packing
100174	T-GD 9 PG BLACK	PG9	20	7	9	1mm - 2mm	3000	Bulk
100175	T-GD 11 PG BLACK	PG11	23	7	11	1mm - 2mm	3000	Bulk
100176	T-GD 13,5 PG BLACK	PG13,5	25	7	13,5	1mm - 2mm	2500	Bulk
100177	T-GD 16 PG BLACK	PG16	28	7	16	1mm - 2mm	2500	Bulk
100178	T-GD 21 PG BLACK	PG21	35	9	21	1mm - 2mm	1000	Bulk
100179	T-GD 29 PG BLACK	PG29	44	10	29	1mm - 2mm	500	Bulk
100180	T-GD 36 PG BLACK	PG36	54	12	36	1.5mm - 3mm	200	Bulk
100181	T-GD 48 PG BLACK	PG48	68	12	48	1.5mm - 3mm	200	Bulk
100182	T-GD 53 PG BLACK	PG53	75	12	53	1.5mm - 3mm	200	Bulk
100721	T-GD 69 PG BLACK	PG69	90	12	69	1.5mm - 3mm	100	Bulk



Cable Grommets

T-GDM

Advantages

- Fast and easy assembly
- Suitable for both indoor and outdoor use
- Fit cut-out dimensions in mm
- Can be used as a plug

Technical Specifications

- IP rating: IP54 (IP65 if used as a plug)
- Material: thermoplastic elastomer
- Colour: black
- Material properties: UL94 V-0
- Material service temperature (unstressed): -40 °C...+100 °C

Dimensions

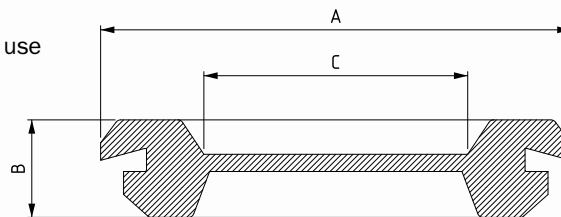

All dimensions to be used only as reference and not for quality control purposes



Art.No.	Description	Cut-out	A	B	C	Plate thickness	Box size	Packing
103665	T-GDM 9 MM BLACK	M12	17	7	9	1mm - 2mm	3000	Bulk
103933	T-GDM 11 MM BLACK	M16	21	7	11	1mm - 2mm	3000	Bulk
100199	T-GDM 13,5 MM BLACK	M20	25	7	13,5	1mm - 2mm	2500	Bulk
100200	T-GDM 16 MM BLACK	M25	32	7	16	1mm - 2mm	2500	Bulk
102342N	T-GDM 21 MM BLACK	M32	40	9	21	1mm - 2mm	1000	Bulk
103523N	T-GDM 29 MM BLACK	M40	48	10	29	1mm - 2mm	500	Bulk
104019N	T-GDM 36 MM BLACK	M50	58	12	36	1.5mm - 3mm	200	Bulk
104022	T-GDM 53 MM BLACK	M75	81	12	53	1.5mm - 3mm	100	Bulk
104023	T-GDM 69 MM BLACK	M90	91	12	69	1.5mm - 3mm	100	Bulk



Cable Grommets

T-RGDM

Advantages

- Fast and easy assembly
- Sealing rings can easily be pulled off without extra tools
- Suitable for both indoor and outdoor use
- Fit M40, M50 or M60 cut-out

Technical Specifications

- IP rating: IP64
- Material: thermoplastic elastomer
- Material properties: UL94 V-0 halogen-free
- Colour: grey and black
- Material service temperature (unstressed): -40 °C...+90 °C

Dimensions

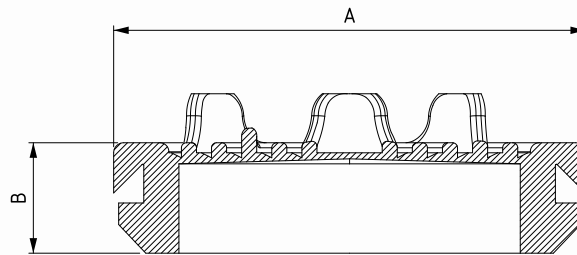

All dimensions to be used only as reference and not for quality control purposes



Art.No.	Description	1 Cable diameter	Cut-out	A	B	Plate thickness	Box size	Packing
107166	T-RGDM 40 BLACK UL94 V-0	10mm - 34mm	M40	47	11	1 - 3.5 mm	400	Bulk
108421	T-RGDM 40 LIGHT GREY UL94 V-0	10mm - 34mm	M40	47	11	1 - 3.5 mm	400	Bulk
106995	T-RGDM 50 BLACK UL94 V-0	12mm - 44mm	M50	57	11	1 - 3.5 mm	250	Bulk
108422	T-RGDM 50 LIGHT GREY UL94 V-0	12mm - 44mm	M50	57	11	1 - 3.5 mm	250	Bulk
107167	T-RGDM 60 BLACK UL94 V-0	12mm - 54mm	M60	67	11	1 - 3.5 mm	200	Bulk
108423	T-RGDM 60 LIGHT GREY UL94 V-0	12mm - 54mm	M60	67	11	1 - 3,5 mm	200	Bulk



Cable Grommets

MGD

Advantages

- Fast and easy assembly
- Suitable for both indoor and outdoor use
- Fit M50 cut-out

Technical Specifications

- IP rating: IP65
- Material: EPDM rubber
- Material properties: halogen-free
- Colour: light grey
- Material service temperature (unstressed): -40 °C...+120 °C

Dimensions

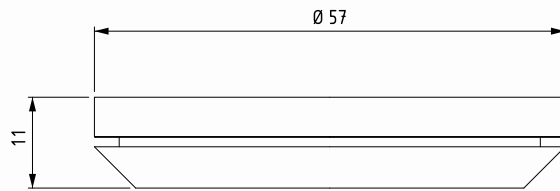

All dimensions to be used only as reference and not for quality control purposes



Art.No.	Description	Installation range	Total of cables	Box size	Packing
106612	M-GD 50-12	8 x 1mm - 9mm 4 x 1mm - 13mm	12 cables	550	Bulk
106613	M-GD 50-7	4 x 1mm - 10mm 3 x 1mm - 16mm	7 cables	550	Bulk



Cable Grommets

M 20-80

Advantages

- Suitable for cable diameters up to 80 mm
- Suitable for both indoor and outdoor use

Technical Specifications

- Material: thermoplastic elastomer
- Material properties: UL94 V-0
- Colour: black and grey
- Material service temperature (unstressed): -40 °C...+100 °C

All dimensions to be used only as reference and not for quality control purposes

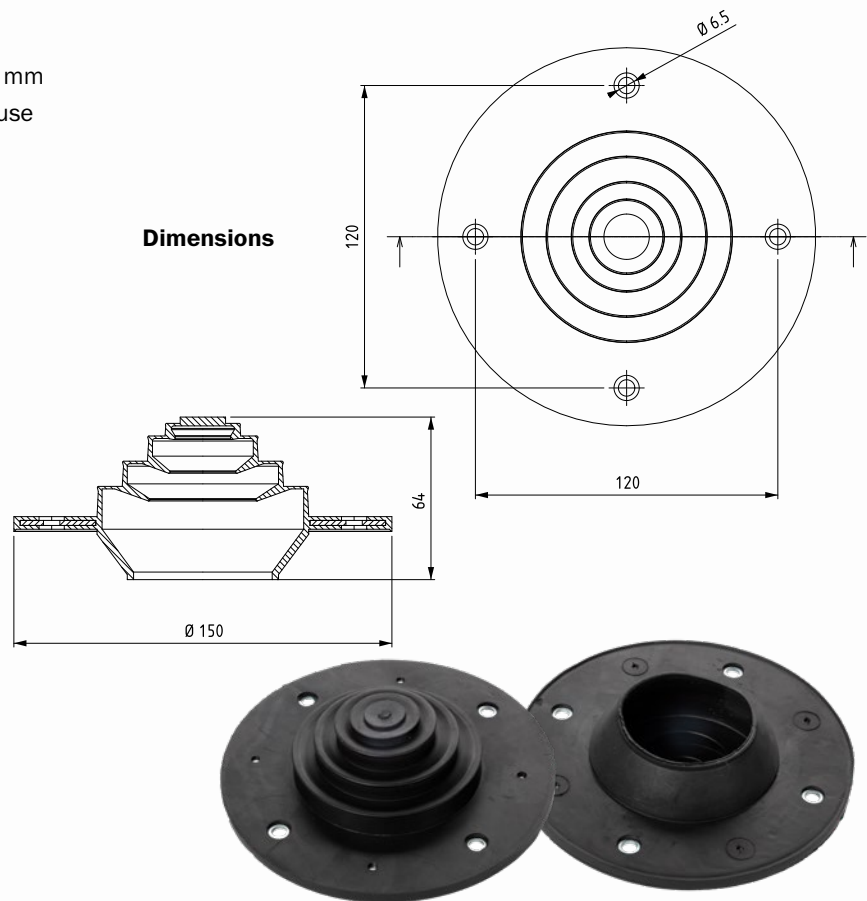

Art.No.	Description	Box size	Packing
104049	M 20-80 LIGHT GREY UL94 V-0	50	Bulk
101035	M 20-80 BLACK UL94 V-0	50	Bulk



Trelleborg is a world leader in engineered polymer solutions that seal, damp and protect critical applications in demanding environments. Its innovative solutions accelerate performance for customers in a sustainable way. The Trelleborg Group has annual sales of about SEK 33 billion (EUR 3.13 billion, USD 3.57 billion) in about 50 countries. The Group comprises three business areas: Trelleborg Industrial Solutions, Trelleborg Sealing Solutions and Trelleborg Wheel Systems. The Trelleborg share has been listed on the Stock Exchange since 1964 and is listed on Nasdaq Stockholm, Large Cap.

WWW.TRELLEBORG.COM

**TRELLEBORG INDUSTRIAL
PRODUCTS FINLAND OY**

KIKKERLÄNTIE 72
38300 SASTAMALA
FINLAND

TRELLEBORG INDIA PVT LTD

PLOT # 285, RAJDHANI INDUSTRIAL
PARK, KIADB AVERAHALLI INDUSTRIAL
AREA, DABASPET, BILLANAKOTE VILLAGE,
BANGALORE – 562111, KARNATAKA
INDIA

**TRELLEBORG
INDUSTRIAL AVS**

NO. 8, ZHONGTONG ROAD
WUXI, J IANGSU
214143
CHINA

CONTACT US AT: CES@TRELLEBORG.COM